

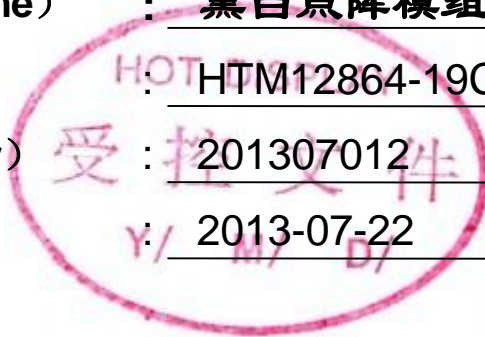

# HTM12864-19C-31S-N3S

产品名称 (Product name) : 黑白点阵模组  
 型号 (Model) : HTM12864-19C-31S-N3S  
 编号 (Part number) : 201307012  
 日期 (Date) : 2013-07-22



深圳市鑫洪泰电子科技有限公司  
 Shenzhen Hot Display Technology Co.,Ltd

编制 Prepared by	审核 Checked by	核准 Approved by

编码: QR-R-011 A/0

序号:

Rev.	Descriptions	Date
01	Prelimiay Release	2014-07-22

# Table of Content

<b>1. Bsaic Specifications</b>	-----	<b>3</b>
1.1 Display Specifications	-----	3
1.2 Mechanical Specifications	-----	3
1.3 Circuit Diagram	-----	3
1.4 Terminal Function	-----	4
1.5 Product Outline	-----	5
1.6 Schematic Diagram	-----	6
<b>2. Absolute Maximum Ratings</b>	-----	<b>7</b>
<b>3. Electrical Characteristics</b>	-----	<b>7</b>
3.1 DC Characteristics	-----	7
3.2 LED Backlight Circuit	-----	7
3.3 AC Characteristics	-----	8
3.4 Reset Timing	-----	9
<b>4. Function specifications</b>	-----	<b>9</b>
4.1 The Parallel Interface	-----	9
4.2 Basic Setting	-----	10
4.3 Resetting the LCD module	-----	10
4.4 Display Memory Map	-----	10
4.5 Display Commands	-----	11
4.6 Basic Operating Sequence	-----	12
<b>5. Inspection Standards</b>	-----	<b>13</b>
<b>6. Handling Precautions</b>	-----	<b>14</b>
6.1 Mounting method	-----	14
6.2 Cautions of LCD handling and cleaning	-----	14
6.3 Caution against static charge	-----	14
6.4 Packaging	-----	14
6.5 Caution for operation	-----	14
6.6 Storage	-----	14
6.7 Safety	-----	14
<b>7 Packaging specifications</b>	-----	<b>15</b>

# 1. Bsaic Specifications

## 1.1 Display Specifications

- 1>LCD Display Mode : FSTN, Positive, Transflective
- 2>Viewing Angle : 6H
- 3>Driving Method : 1/64 Duty, 1/9 Bias
- 4>Backlight : Three kinds of color

## 1.2 Mechanical Specifications

- 1>Outline Dimension : 45.0x 42.0x 6.5mm (See attached Outline Drawing for Details)

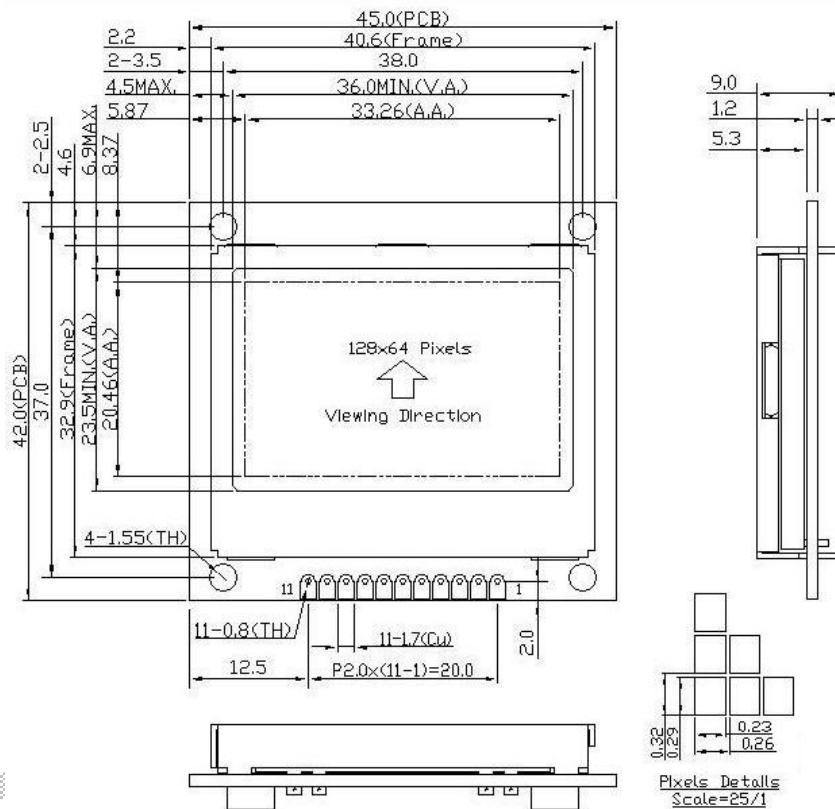

## 1.3 Circuit Diagram

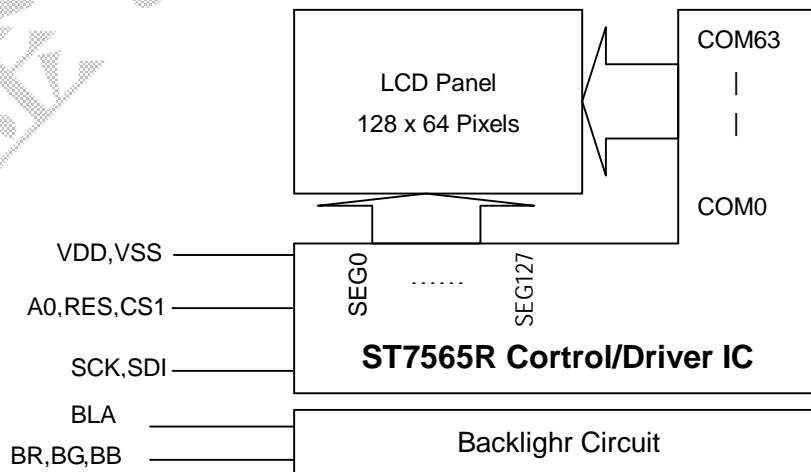

#### 1.4 Terminal Function

Pin No.	Pin Name	Function
1	CS1	Chip select signal.
2	RES	Rester Pin(L->H)
3	A0	A0 = "H": Indicates that SDI is display data. A0 = "L": Indicates that SDI is control data.
4	SCK	Serial clock input (SCL).
5	SDI	Serial data input (SI);
6	VSS	Negative power supply,0V
7	VDD	Positive power supply,3.3V
8	BLA	Positive power supply for Backlight (3.3V)
9	BR	Backlight R_LED Control Pin (VSS Active)
10	BG	Backlight G_LED Control Pin (VSS Active)
11	BB	Backlight B_LED Control Pin (VSS Active)

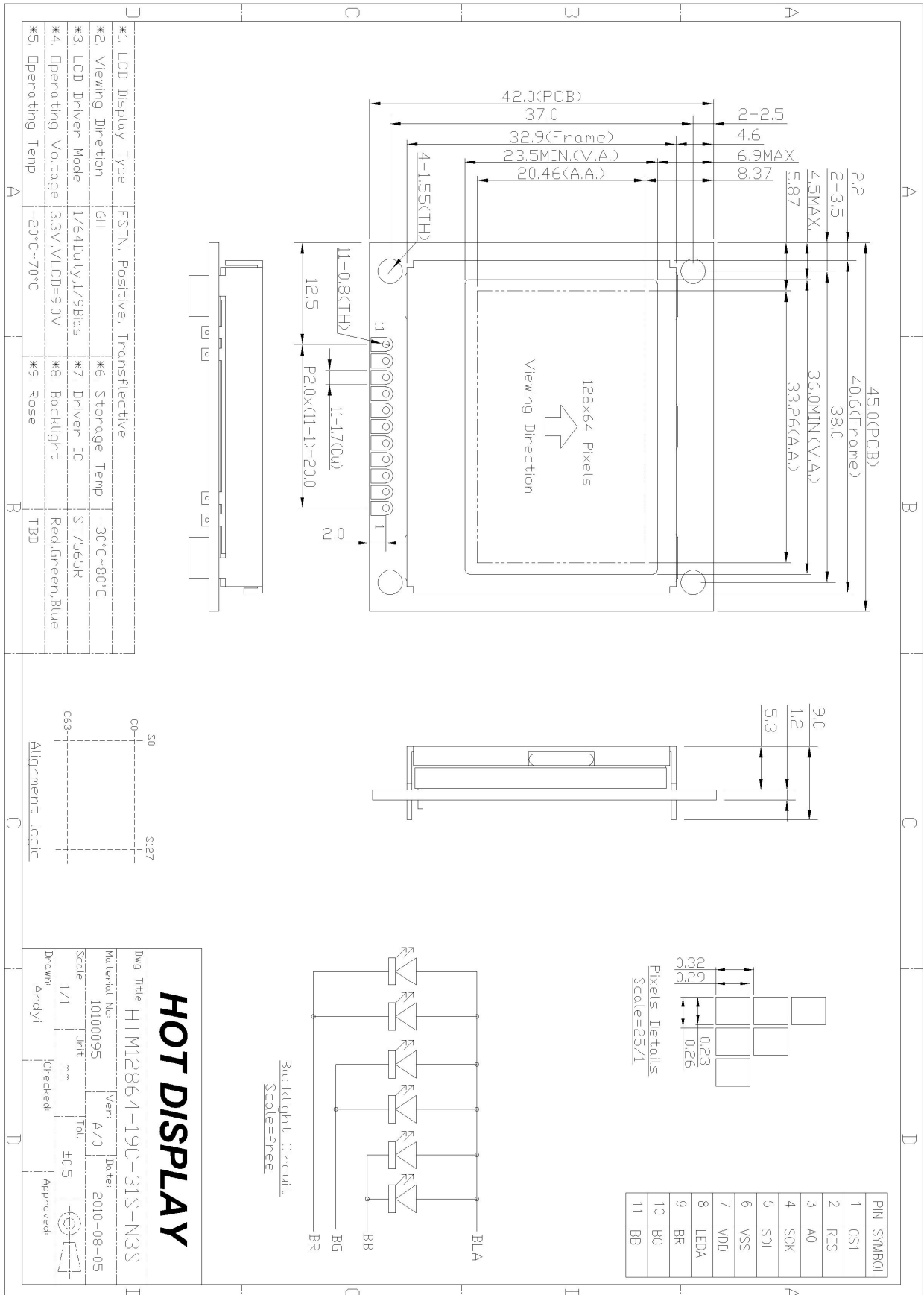
**1.5 Product Outline**

1.6 Schematic Diagram

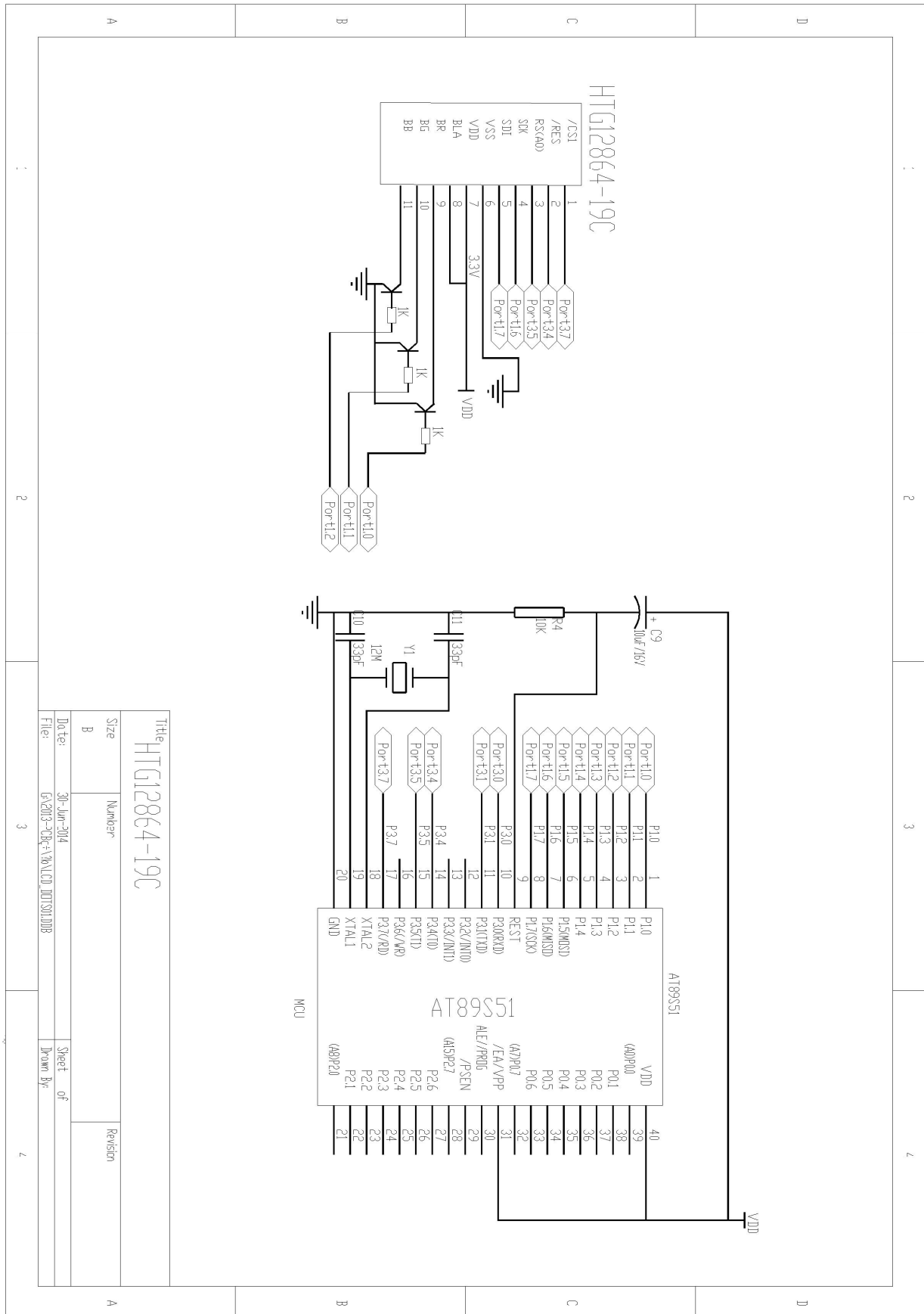

## 2. Absolute Maximum Ratings

Items	Symbol	MIN.	MAX.	Unit	Condition
Supply Voltage	V <sub>DD</sub>	-0.3	+3.6	V	V <sub>SS</sub> = 0V
Input Voltage	V <sub>IN</sub>	-0.3	V <sub>DD</sub> +0.3	V	V <sub>SS</sub> = 0V
Operating Temperature	T <sub>OP</sub>	-20	+70	°C	No Condensation
Storage Temperature	T <sub>st</sub>	-30	+80	°C	No Condensation

## 3. Electrical Characteristics

### 3.1 DC Characteristics

V<sub>SS</sub> = 0V, Top = 25°C

Items	Symbol	MIN.	TYP.	MAX.	Unit	Condition
Operating Voltage	V <sub>DD</sub>	2.4	3.3	3.6	V	-
Input High Voltage	V <sub>IH</sub>	0.8 x V <sub>DD</sub>	-	V <sub>DD</sub>	V	/CS1,/RES,A0
Input Low Voltage	V <sub>IL</sub>	V <sub>SS</sub>	-	0.2 x V <sub>DD</sub>	V	SCK,SDI
Output High Voltage	V <sub>OH</sub>	0.8 x V <sub>DD</sub>	-	V <sub>DD</sub>	V	-
Output Low Voltage	V <sub>OL</sub>	V <sub>SS</sub>	-	0.2 x V <sub>DD</sub>	V	-
Input Leakage Current	I <sub>LI</sub>	-1.0	-	1.0	μA	-
Output Leakage Current	I <sub>Lo</sub>	-3.0	-	3.0	μA	-
Operation Current	I <sub>OP</sub>	-	100	210	μA	V <sub>OUT</sub> =6.0~13.5V
Standby Mode	I <sub>DD</sub>	-	5	10	μA	T <sub>a</sub> = 25°C
Sleep Mode	I <sub>SL</sub>	-	0.1	4	μA	Display OFF

### 3.2 LED Backlight Circuit

V<sub>SS</sub> = 0V, Top = 25°C

Items	Symbol	MIN.	TYP.	MAX.	Unit	Condition
Forward Voltage	V <sub>f</sub> BLA	-	3.1	-	V	Wtihout Resister
Forward Current	I <sub>f</sub> BLA	-	30	40	mA	A kind of color

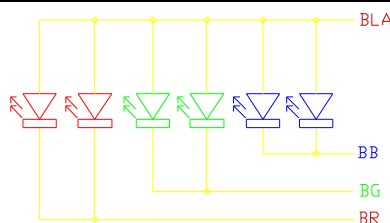

### 3.3 AC Characteristics(4-line SPI Mode)

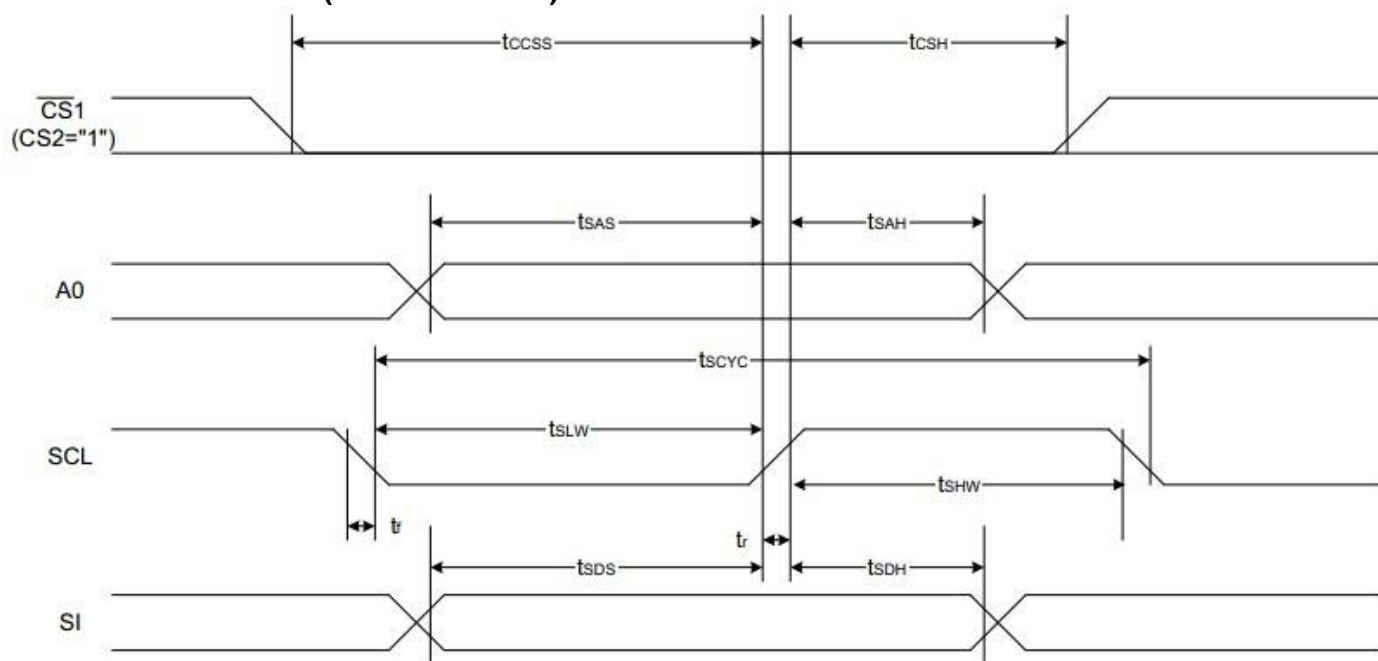

( $V_{DD} = 3.3V, T_a = -30 \text{ to } 85^\circ\text{C}$ )

Item	Signal	Symbol	Condition	Rating		Units
				Min.	Max.	
4-line SPI Clock Period	SCL	$T_{scyc}$		50	—	ns
SCL "H" pulse width		$T_{shw}$		25	—	
SCL "L" pulse width		$T_{slw}$		25	—	
Address setup time	A0	$T_{sas}$		20	—	
Address hold time		$T_{sah}$		10	—	
Data setup time	SI	$T_{sds}$		20	—	
Data hold time		$T_{sdh}$		10	—	
CS-SCL time	CS	$T_{css}$		20	—	
CS-SCL time		$T_{csh}$		40	—	

( $V_{DD} = 1.8V, T_a = -30 \text{ to } 85^\circ\text{C}$ )

Item	Signal	Symbol	Condition	Rating		Units
				Min.	Max.	
4-line SPI Clock Period	SCL	$T_{scyc}$		200	—	ns
SCL "H" pulse width		$T_{shw}$		80	—	
SCL "L" pulse width		$T_{slw}$		80	—	
Address setup time	A0	$T_{sas}$		60	—	
Address hold time		$T_{sah}$		30	—	
Data setup time	SI	$T_{sds}$		60	—	
Data hold time		$T_{sdh}$		30	—	
CS-SCL time	CS	$T_{css}$		40	—	
CS-SCL time		$T_{csh}$		100	—	



### 3.4 Reset Timing

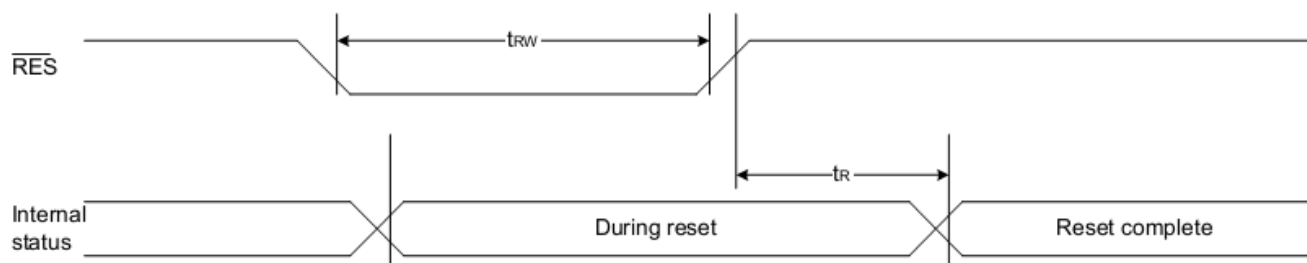

( $V_{DD} = 3.3V, T_a = -30 \text{ to } 85^\circ\text{C}$ )

Item	Signal	Symbol	Condition	Rating			Units
				Min.	Typ.	Max.	
Reset time		$t_R$		—	—	1.0	us
Reset "L" pulse width	/RES	$t_{RW}$		1.0	—	—	us

Table 37

( $V_{DD} = 2.7V, T_a = -30 \text{ to } 85^\circ\text{C}$ )

Item	Signal	Symbol	Condition	Rating			Units
				Min.	Typ.	Max.	
Reset time		$t_R$		—	—	2.0	us
Reset "L" pulse width	/RES	$t_{RW}$		2.0	—	—	us

Table 38

( $V_{DD} = 1.8V, T_a = -30 \text{ to } 85^\circ\text{C}$ )

Item	Signal	Symbol	Condition	Rating			Units
				Min.	Typ.	Max.	
Reset time		$t_R$		—	—	3.0	us
Reset "L" pulse width	/RES	$t_{RW}$		3.0	—	—	us

**Note:**

\*a. all timing is using 20% and 80% of VDD as the reference.

## 4. Function specifications

### 4.1 The 4Line SPI Interface Signal Chart

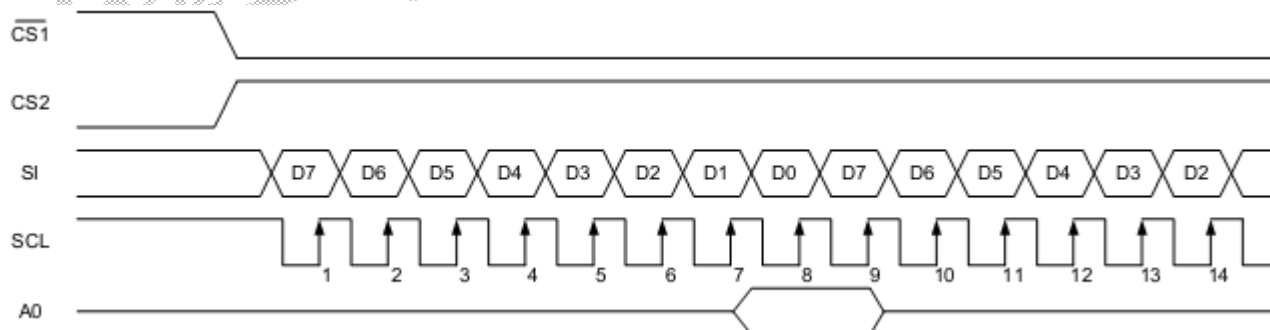

### 4.2 Basic Setting

To drive the LCD module correctly and provide normally display, please use the following setting

- 1> ADC = 0 (normal)
- 2> SHL select = 1(reverse)
- 3> LCD Bias Select = 1/9
- 4> Initial Display Line = 0
- 5> Entire Display ON/OFF = OFF(normal)
- 6> Reverse Display ON/OFF = OFF(normal)
- 7> Set Power Control Set:  
Voltage follower = ON,voltage converter = ON,Voltage regulator = ON
- 8> Display ON/OFF =ON

### 4.3 Resetting the LCD module

The LCD module should be initialized bu using /RES terminal.  
While turning on the VDD and VSS power supply, maintain /RES terminal at LOW level, After the Power supply stabilized, release the reset terminal(/RES = High)

### 4.4 Display Memory Map

LCD Display (front view)

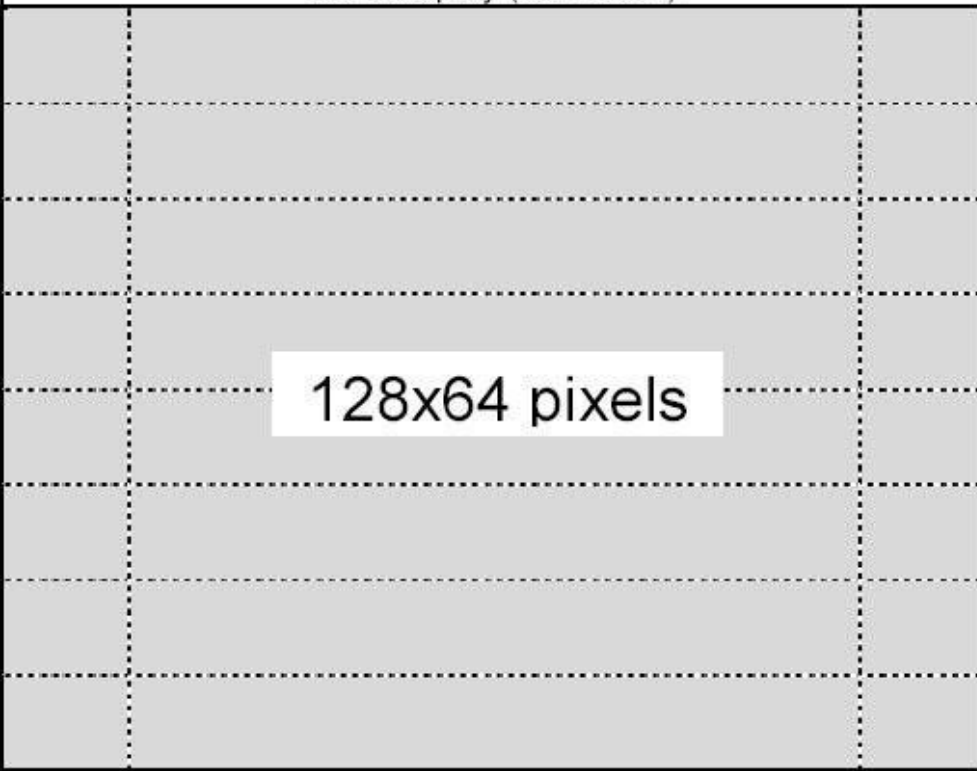
Page address	data			
0	D0 : D7			
1	D0 : D7			
2	D0 : D7			
3	D0 : D7			
4	D0 : D7			
5	D0 : D7			
6	D0 : D7			
7	D0 : D7			
Column Address		00h	→	7Fh

### 4.5 Display Commands

No.	Instrctions	Code											Function	
		A0	/RD	/WR	D7	D6	D5	D4	D3	D2	D1	D0		
1	Display ON/OFF	0	1	0	1	0	1	0	1	1	1	1	DON	DON=0,display off DON=1,display on
2	Display start line set	0	1	0	0	1	Display start address						Set the display RAM display start line address	
3	Set Page Address	0	1	0	1	0	1	1	Page address					Set the display RAM Page address
4	Ser Column Address (Upper-4 bits)	0	1	0	0	0	0	1	Col. Add					Set the upper-4-bit of column address counter
	Ser Column Address (Lower-4 bits)	0	1	0	0	0	0	0	Col. Add					Set the low-4-bit of column address counter
5	Read Staus	0	0	1	Status				0	0	0	0		Read the status data
6	Write Display Data	1	1	0	Write Data								Write data into the display RAM	
7	Read Display Data	1	0	1	Read Data								Read data from the display RAM	
8	ADC Select	0	1	0	1	0	1	0	0	0	0	0	ADC	Set the display RAM address SEG output Correspondence ADC = 0,Normal. ADC = 1,Reverse
9	Normal/Reverse Display	0	1	0	1	0	1	0	0	1	1		REV	REV = 0, Normal REV = 1, Reverse
10	Entire Display ON/OFF	0	1	0	1	0	1	0	0	1	0		EON	EON = 0, Normal EON = 1, Entire display ON
11	Set LCD Bias	0	1	0	1	0	1	0	0	0	1		BIAS	Bias = 0, 1/9 Bias Bias = 1, 1/7 Bias
12	Set Read-Modify-Write	0	1	0	1	1	1	0	0	0	0	0		Enter the "Read-Modify-Write" mode
13	Reset Read-Modify-Write	0	1	0	1	1	1	0	1	1	1	0		Clear the "Read-Modify-Write" mode
14	Reset	0	1	0	1	1	1	0	0	0	1	0		Resets the LCD module
15	SHL S elect	0	1	0	1	1	0	0	SHL	*	*	*		Set the COM scanning direction SHL = 0, Normal SHL = 1, Flipped in y-direction * = don't care terms
16	Power Control Set	0	1	0	0	0	1	0	1	VC	VR	VF		Set the power circuit operation mode VF : LCD Supply Voltage Follower VR : LCD Supply Voltage Regulator VF : LCD Supply Voltage Converter (1 = ON, 0 = OFF)
17	Regulator Resistor Select	0	1	0	0	0	1	0	0	Ratio				Set the built-in resistor ratio (Rb/Ra)
18	Electronic volume mode set	0	1	0	1	0	0	0	0	0	0	1		Set reference voltage mode
	Electronic volume register set	0	1	0	*	*	Electronic Control value						Set reference voltage register	
19	Power Save	-	-	-	-	-	-	-	-	-	-	-		Compound instruction Display OFF + Entire Display ON
20	NOP	0	1	0	1	1	1	0	0	0	1	1		Non-operation command

**Note:**

\*a. For the details of the Display Commands, please refer to ST7565R data sheet

### 4.6 Basic Operating Sequence

#### Initialization Sequence

	Code Function										Note	
	A0	D7	D6	D5	D4	D3	D2	D1	D0	hex		
Turn on Power Supply VDD & VSS While maintaining /RES at LOW	-	-	-	-	-	-	-	-	-	-	-	
Wait until power supply is stabilized	-	-	-	-	-	-	-	-	-	-	-	
Release the /RES Reset Signal (/RES = High)	-	-	-	-	-	-	-	-	-	-	-	See AC Characteristics section for timing details
LCD Bias = 1/9	0	1	0	1	0	0	0	1	0	0	A2H	LCD Characteristics
ADC = Normal	0	1	0	1	0	0	0	0	0	0	A0H	No flip on x-direction (SEG)
SHL = Reverse	0	1	1	0	0	1	0	0	0	0	C8H	Flip on y- direction (COM)
Initial Display Line = 0	0	0	1	0	0	0	0	0	0	0	40H	i.e. Display RAM "Page 0-D0" Matched to top line of the LCD
Power Control Voltage Follower = OFF Voltage Regulator = OFF Voltage Converter = ON Delay 50ms	0	0	0	1	0	1	1	0	0	0	2CH	Turn on the internal Voltage Converter and wait until VOUT stable
	-	-	-	-	-	-	-	-	-	-	-	
Power Control Voltage Follower = OFF Voltage Regulator = OFF Voltage Converter = ON Delay 50ms	0	0	0	1	0	1	1	1	0	0	2EH	Turn on the internal Voltage Regulator and wait until VOUT stable
	-	-	-	-	-	-	-	-	-	-	-	
Power Control Voltage Follower = OFF Voltage Regulator = OFF Voltage Converter = ON Delay 50ms	0	0	0	1	0	1	1	1	1	0	2FH	Turn on the internal Voltage Follower and wait until VOUT stable
	-	-	-	-	-	-	-	-	-	-	-	
Regulator Resistor Select	0	0	0	1	0	0	1	0	1	0	25H	Set the built-in resistor ratio to middle
Set Reference Voltage Mode Set Reference Voltage Resistor	0	1	0	0	0	0	0	0	1	0	81H	Set to the middle of the range it may be adjusted For achieving the best display contrast
	0	0	0	1	0	0	0	1	0	0	22H	
Display ON	0	1	0	1	0	1	1	1	1	1	AFH	Turn on the LCD display
Set Page Address = 0	0	1	0	1	1	0	0	0	0	0	B0H	Specify the display data RAM page address to 00H
Set Column Address (Upper -4bit = 0) Set Column Address (Lower-4bit =4)	0	0	0	0	1	0	0	0	0	0	10H	Specify the display data RAM column address to 00H
	0	0	0	0	0	0	1	0	0	0	01H	
Write Display Data	1	Display Data									-	
Write Other Display Data												

## 5. Inspection Standards

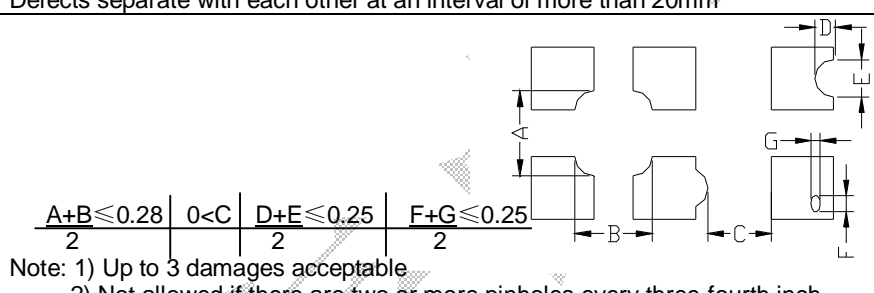
Item	Criterion for defects	Defect type
1) Display on inspection	(1) Non display (2) Vertical line is deficient (3) Horizontal line is deficient (4) Cross line is deficient	Major
2) Black / White spot	Size $\Phi$ (mm) Acceptable number $\Phi \leq 0.3$ Ignore (note) $0.3 < \Phi \leq 0.45$ 3 $0.45 < \Phi \leq 0.6$ 1 $0.6 < \Phi$ 0	Minor
3) Black / White line	Length (mm) Width (mm) Acceptable number $L \leq 10$ $W \leq 0.03$ Ignore $5.0 \leq L \leq 10$ $0.03 < W \leq 0.04$ 3 $5.0 \leq L \leq 10$ $0.04 < W \leq 0.05$ 2 $1.0 \leq L \leq 10$ $0.05 < W \leq 0.06$ 2 $1.0 \leq L \leq 10$ $0.06 < W \leq 0.08$ 1 $L \leq 10$ $0.08 < W$ follows 2) point defect Defects separate with each other at an interval of more than 20mm	Minor
4) Display pattern	 <p>Note: 1) Up to 3 damages acceptable 2) Not allowed if there are two or more pinholes every three-fourth inch.</p>	Minor
5) Spot-like contrast irregularity	Size $\Phi$ (mm) Acceptable Number $\Phi \leq 0.7$ Ignore (note) $0.7 < \Phi \leq 1.0$ 3 $1.0 < \Phi \leq 1.5$ 1 $1.5 < \Phi$ 0 Note: 1) Conformed to limit samples. 2) Intervals of defects are more than 30mm.	Minor
6) Bubbles in polarizer	Size $\Phi$ (mm) Acceptable Number $\Phi \leq 0.4$ Ignore (note) $0.4 < \Phi \leq 0.65$ 2 $0.65 < \Phi \leq 1.2$ 1 $1.2 < \Phi$ 0	Minor
7) Scratches and dent on the polarizer	Scratches and dent on the polarizer shall be in the accordance with “2) Black/white spot”, and “3) Black/White line”.	Minor
8) Stains on the surface of LCD panel	Stains which cannot be removed even when wiped lightly with a soft cloth or similar cleaning.	Minor
9) Rainbow color	No rainbow color is allowed in the optimum contrast on state within the active area.	Minor
10) Viewing area encroachment	Polarizer edge or line is visible in the opening viewing area due to polarizer shortness or sealing line.	Minor
11) Bezel appearance	Rust and deep damages that are visible in the bezel are rejected.	Minor
12) Defect of land surface contact	Evident crevices that are visible are rejected.	Minor
13) Parts mounting	(1) Failure to mount parts (2) Parts not in the specifications are mounted (3) For example: Polarity is reversed, HSC or TCP falls off.	Minor
14) Part alignment	(1) LSI, IC lead width is more than 50% beyond pad outline. (2) More than 50% of LSI, IC leads is off the pad outline.	Minor
15) Conductive foreign matter (solder ball, solder hips)	(1) $0.45 < \Phi$ , $N \geq 1$ (2) $0.3 < \Phi \leq 0.45$ , $N \geq 1$ , $\Phi$ : Average diameter of solder ball (unit: mm) (3) $0.5 < L$ , $N \geq 1$ , L: Average length of solder chip (unit: mm)	Minor
16) Bezel flaw	Bezel claw missing or not bent	Minor
17) Indication on name plate (sampling indication label)	(1) Failure to stamp or label error, or not legible.(all acceptable if legible) (2) The separation is more than 1/3 for indication discoloration, in which the characters can be checked.	Minor

## 6. Handling Precautions

### 6.1 Mounting method

A panel of LCD module made by our company consists of two thin glass plates with polarizers that easily get damaged. And since the module is so constructed as to be fixed by utilizing fitting holes in the printed circuit board (PCB), extreme care should be used when handling the LCD modules.

### 6.2 Cautions of LCD handling and cleaning

When cleaning the display surface, use soft cloth with solvent (recommended below) and wipe lightly.

- Isopropyl alcohol
- Ethyl alcohol
- Trichlorotrifluoroethane

Do not wipe the display surface with dry or hard materials that will damage the polarizer surface.

Do not use the following solvent:

- Water
- Ketene
- Aromatics

### 6.3 Caution against static charge

The LCD module uses C-MOS LSI drivers. So we recommend you:

Connect any unused input terminal to  $V_{dd}$  or  $V_{ss}$ . Do not input any signals before power is turned on, and ground your body, work/assembly areas, assembly equipment to protect against static electricity.

### 6.4 Packaging

- Module employs LCD elements, and must be treated as such. Avoid intense shock and falls from a height.
- To prevent modules from degradation, do not operate or store them exposed direct to sunshine or high temperature/humidity.

### 6.5 Caution for operation

-It is an indispensable condition to drive LCD module within the limits of the specified voltage since the higher voltage over the limits may cause the shorter life of LCD module.

- An electrochemical reaction due to DC (direct current) causes LCD undesirable deterioration so that the uses of DC (direct current) drive should be avoided.

-Response time will be extremely delayed at lower temperature than the operating temperature range and on the other hand at higher temperature LCD module may show dark color in them. However those phenomena do not mean malfunction or out of order of LCD module, which will come back in the specified operating temperature.

### 6.6 Storage

In the case of storing for a long period of time, the following ways are recommended:

- Storage in polyethylene bag with the opening sealed so as not to enter fresh air outside in it. And with not desiccant.
- Placing in a dark place where neither exposure to direct sunlight nor light is. Keeping the storage temperature range.
- Storing with no touch on polarizer surface by any thing else.

### 6.7 Safety

-It is recommendable to crash damaged or unnecessary LCD into pieces and to wash off liquid crystal by either of solvents such as acetone and ethanol, which should be burned up later.

-When any liquid leaked out of a damaged glass cell comes in contact with your hands, please wash it off well at once with soap and water.

## 7. Packaging Specifications

	<b>Packaging Specifications</b> HTM12864-19C	Approved	Checked	Designed

### 6.1 Packaging Material

No	Item	Dimensions (mm)	1PCS Weight (KG)	Quantity	Total Weight
1	LCM	45.0*42.0*9.0	0.017	400	6.8
2	PE Bag	80*80	0.001	400	0.3
3	Foam Rubber Cushion	310*170	0.0175	8	0.21
4	Partition A1	310*170*100	0.30	4	1.8
5	Product Box	330*180*120 (neutral packing)	0.45	4	2.7
6	Carton	480*390*330 (neutral packing)	1.0	1	1.0
7	Tape			AR	
8	Label Specifications			1	
9	Label Rohs			1	
10	Label ESD			1	

6.2. Total LCD Weight in carton: 12.8 KG±10%

6.3. Packaging Specifications and Quantity:

(1) Quantity Of Spacer: A1\*4

(2) Total LCM quantity in carton: quantity per box 100\* no of boxes 4 =400

